

SALAMANDER

405 065

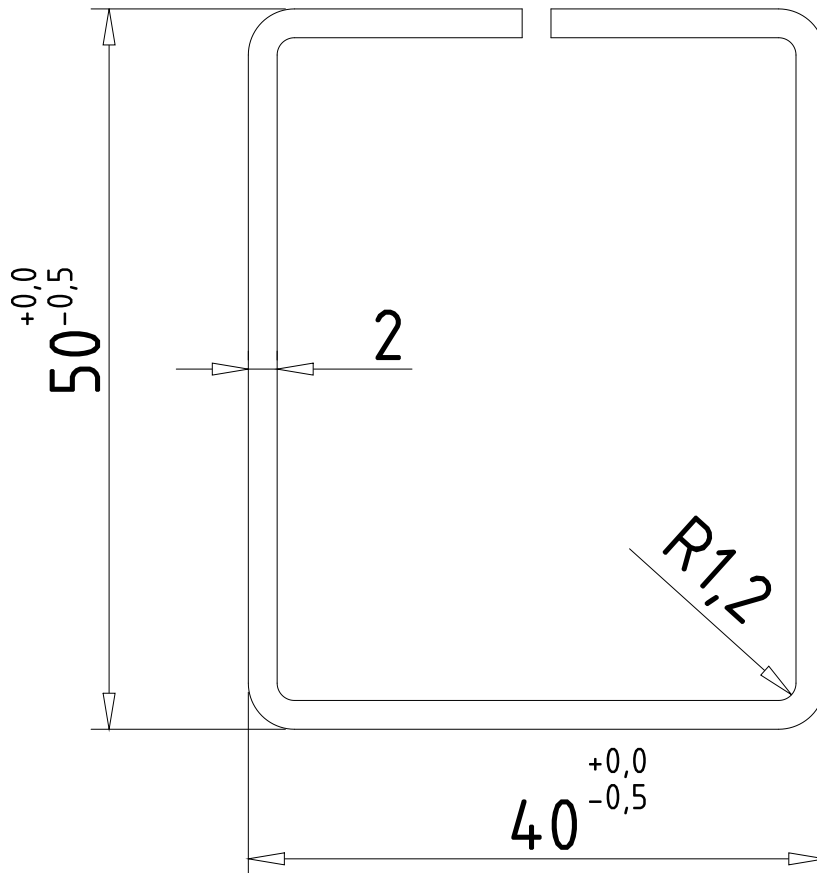

				DX51D+Z			CD PROFIL,s.r.o Ul.1.mája 2070 03101 Liptovský Mikuláš SLOVENSKO	
Poz.	Nazov-rozmer	Vykres-norma		Material	Jedn.	Mn.	Tel: 044/5621676 Tel./Fax: 044/5514542	
Index	Zmena	Datum	Podpis	Hlav.ries:				
				Hlav.konstr:				
				Kreslil:				
				Schválil:				
Mierka	Nazov				Poznámka:			
2:1	SALAMANDER 405 065							
				Listov: 1	List: 1	Datum: 20.3.2007		