

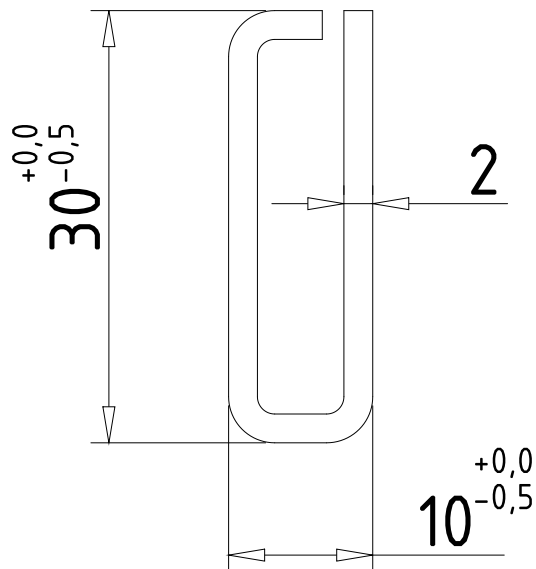

SALAMANDER

405 010



			DX51D+Z			CD PROFIL,s.r.o Ul.1.mája 2070 03101 Liptovský Mikuláš SLOVENSKO	
Poz.	Nazov-rozmer	Vykres-norma	Material	Jedn.	Mn.	Tel: 044/5621676 Tel./Fax: 044/5514542	
Index	Zmena	Datum	Podpis	Hlav.ries:			
				Hlav.konstr:			
				Kreslil:			
				Schválil:			
Mierka	Nazov			Poznámka:			
2:1	SALAMANDER 405 010						
				Listov: 1	List: 1	Datum: 20.3.2007	